

# **ICO FITNESS PROJECT**

# TREADMILL SCH 510T

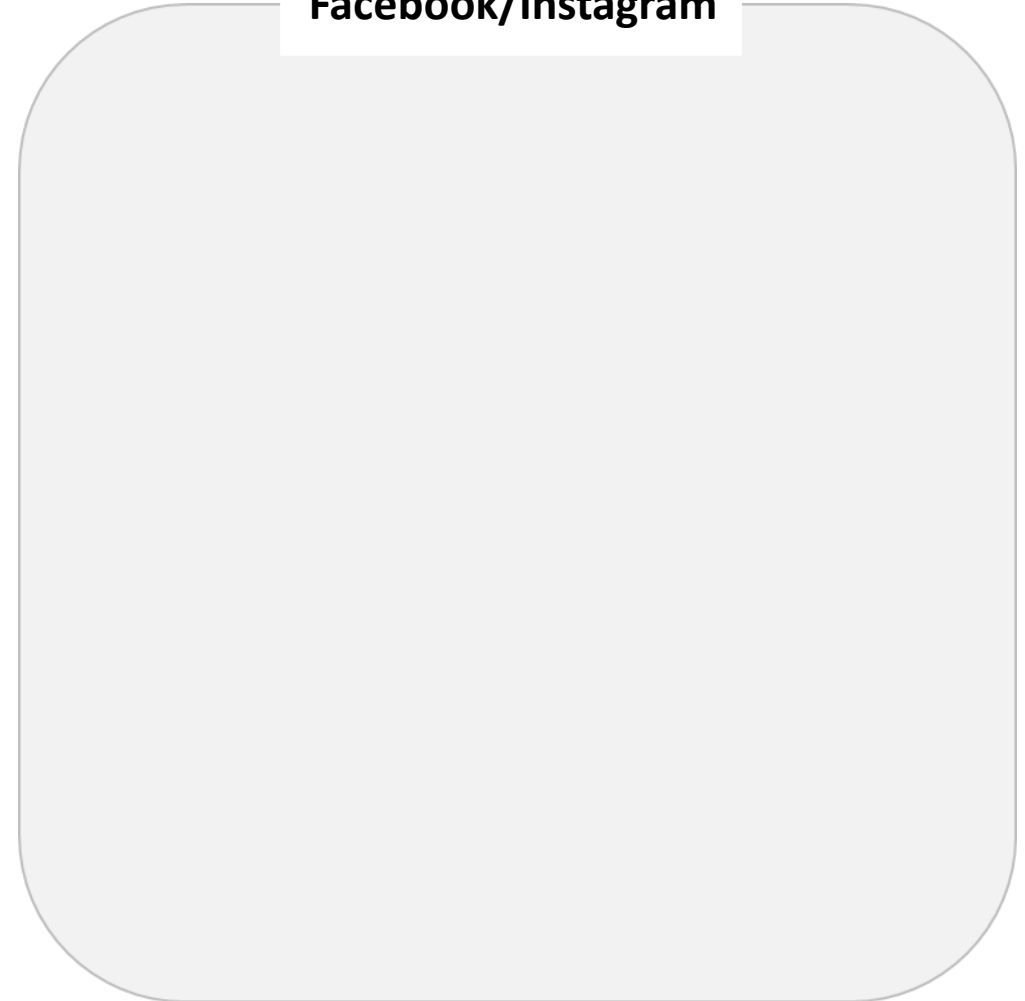

Content for  
Facebook/Instagram





Content for  
Facebook/Instagram



Content for  
Facebook/Instagram





Content for  
Facebook/Instagram



Content for  
Facebook/Instagram

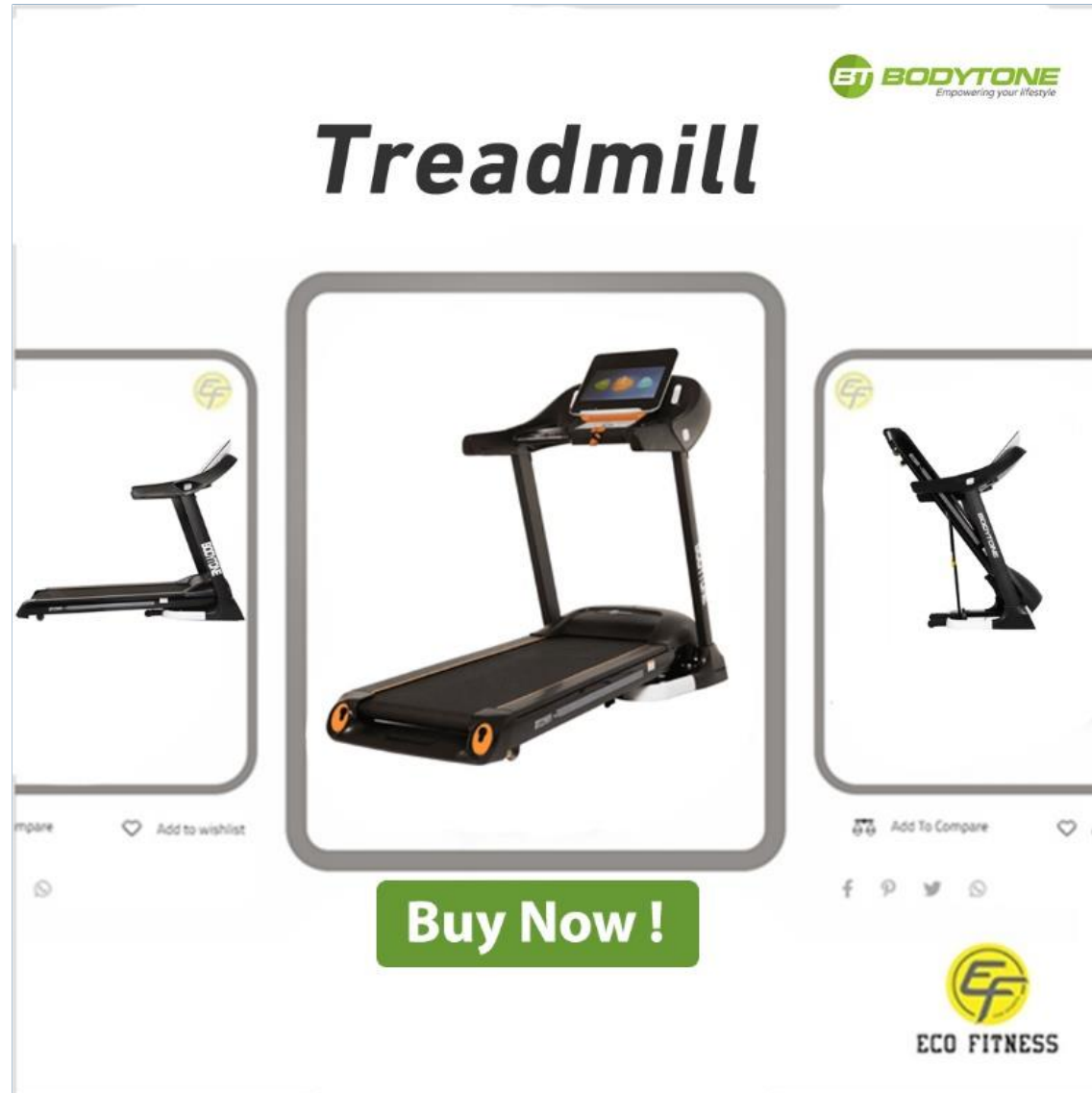

**ETJ BODYTONE**  
Empowering your lifestyle

# Treadmill

Compare Add to wishlist

Add To Compare Add

f p t s

**Buy Now !**

**ECO FITNESS**

The advertisement features a central image of a black treadmill with a digital display, highlighted by a thick grey border. To its left and right are smaller images of the same treadmill from different angles. The top right corner contains the 'ETJ BODYTONE' logo with the tagline 'Empowering your lifestyle'. The word 'Treadmill' is written in a large, bold, italicized font. Below the main image is a green 'Buy Now !' button. At the bottom, there are social media sharing icons (Facebook, Print, Twitter, Share) and the 'ECO FITNESS' logo.

Content for  
Facebook/Instagram

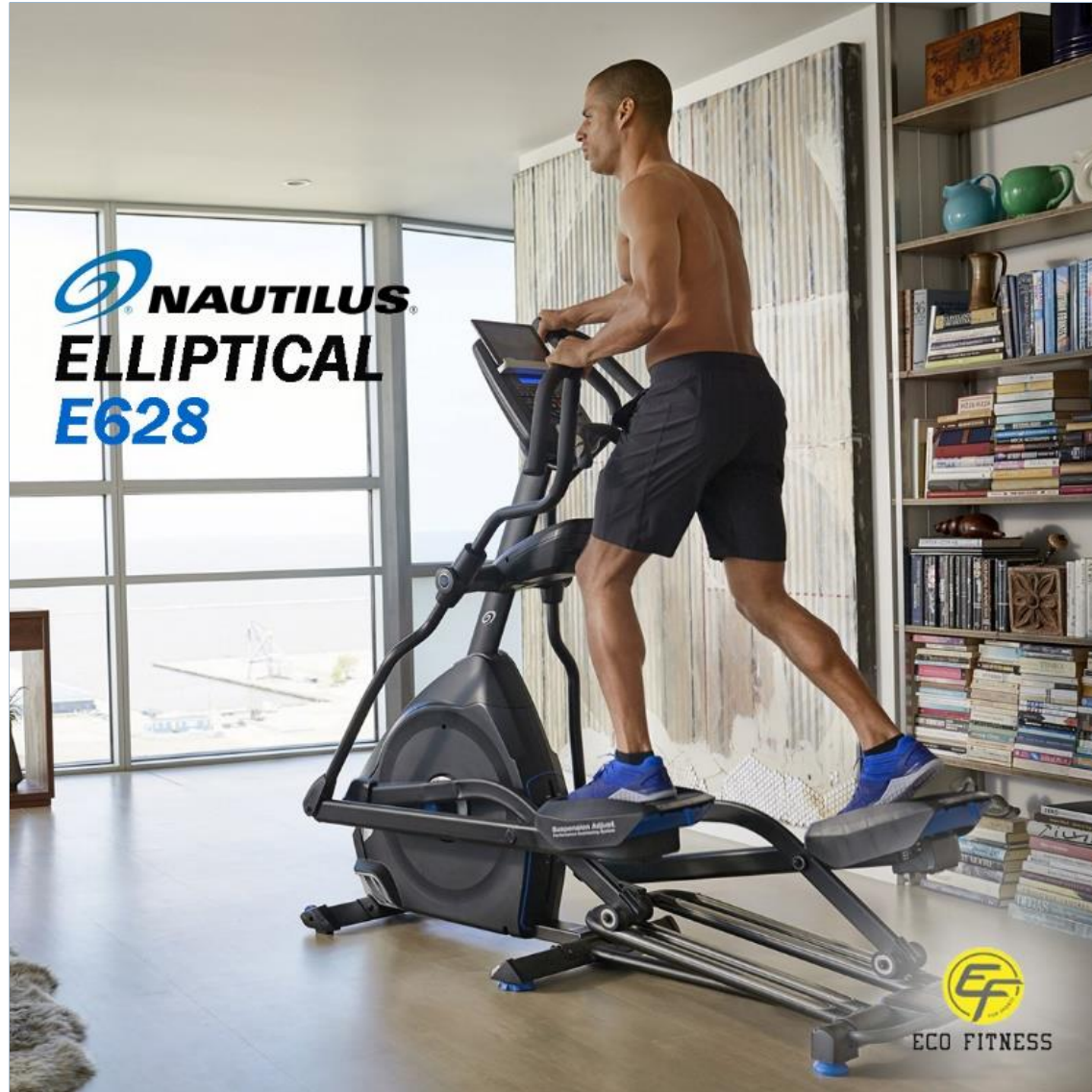

Content for  
Facebook/Instagram







**Content for  
Facebook/Instagram**

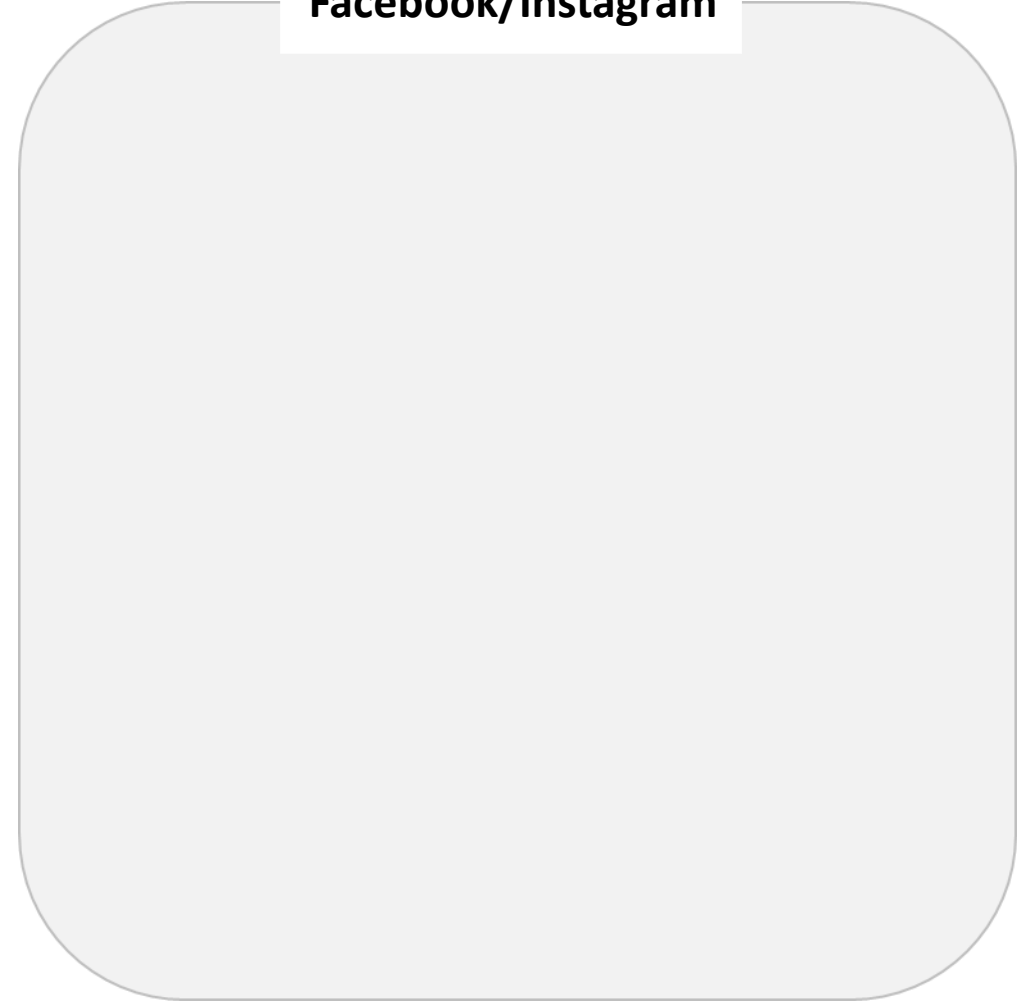



# UPRIGHT BIKE U627

Weight 30 kg



**Buy Now!**



Content for  
Facebook/Instagram





# SCH 510U UPRIGHT BIKE

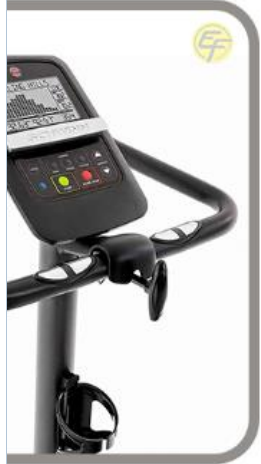

mpare    Add to wishlist

Add To Compare    Ac

**Buy Now!**



ECO FITNESS

Content for  
Facebook/Instagram



**NAUTILUS**

# Upright Bike NLS U626

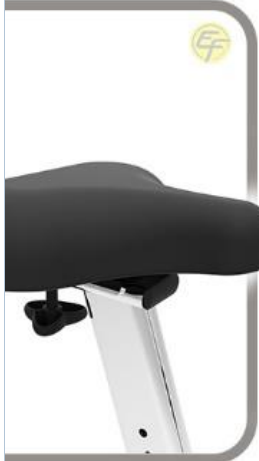

Compare  Add to wishlist



**Buy Now!**



Add To Compare  Add to wishlist

[f](#) [p](#) [t](#) [i](#)



ECO FITNESS

Content for  
Facebook/Instagram



**Content for  
Facebook/Instagram**

**EF BODYTONE**  
**EVOU4**  
**UPRIGHT BIKE**



mpare    Add to wishlist

Add To Compare    Ac

f   p   t   s

**Buy Now!**

**EF**  
**ECO FITNESS**

**NAUTILUS**  
**NLS R626**  
**RECUMBENT BIKE**



Compare  Add to wishlist



**Buy Now!**



Add To Compare  Add to wishlist

f p t i



ECO FITNESS

**Content for  
Facebook/Instagram**



**RECUMBENT BIKE**

MY20, INTL

**SCH 510R**



**Content for  
Facebook/Instagram**



**ET BODYTONE**

# **EVOR4** **Recumbent Bike**



Weight 135 kg  
Dimensions 148 × 66 × 130 cm

**Buy Now!**



**Content for  
Facebook/Instagram**







Content for  
Facebook/Instagram

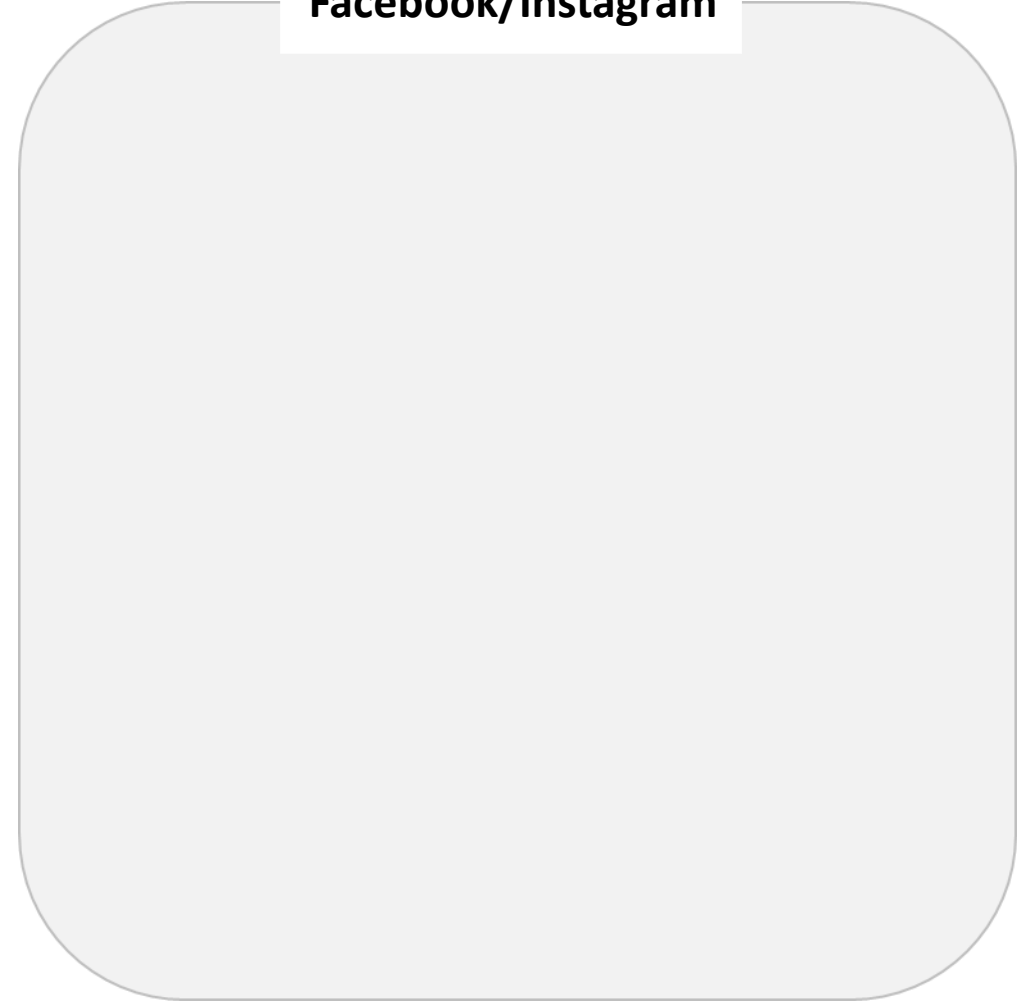



Content for  
Facebook/Instagram





**Content for  
Facebook/Instagram**





Content for  
Facebook/Instagram



**HOLST**

# 2 STACK MULTI GYM BASE UNIT



ECO FITNESS

Content for  
Facebook/Instagram

**HOIST**

# 4 STACK MULTI GYM BASE UNIT



ECO FITNESS

Content for  
Facebook/Instagram

# FUNCTIONAL TRAINER Mi6



Content for  
Facebook/Instagram



# M17 Smith Functional Training System



Compare [Add to wishlist](#)

[Add To Compare](#) [Add to wishlist](#)

**Buy Now!**



ECO FITNESS

Content for  
Facebook/Instagram





# MiTHOME GYM

## HOIST FITNESS

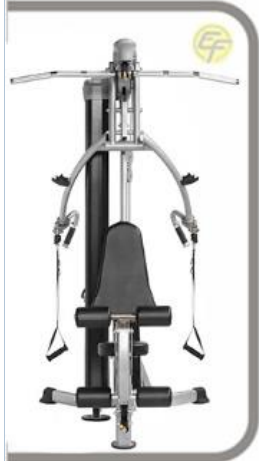

Compare  Add to wishlist

 Add To Compare  Ac

**Buy Now!**



ECO FITNESS

Content for  
Facebook/Instagram



BASE UNIT  
**WITH**  
SEATED LEG CURL FOR V UNITS



mpare Add to wishlist

Add To Compare Ac

**Buy Now!**



ECO FITNESS

Content for  
Facebook/Instagram



**Content for  
Facebook/Instagram**

**HOIST**  
FITNESS

**RANGE OF MOTION ARM**



Compare Add to wishlist

Add To Compare Ac

f p t s

**Buy Now!**



**ECO FITNESS**

# 7-POSITION F.I.D. OLYMPIC BENCH



Content for  
Facebook/Instagram



**LEG EXTENSION / LEG CURL  
FOR  
HF-5165 & HF-5170**



Weight: 22.10 kg  
Dimensions 48x54x53 cm

**Buy Now!**



**Content for  
Facebook/Instagram**



**PREACHER CURL ATTACHMENT  
FOR  
HF-5165 & HF-5170**



Weight: 20 9 kg  
Dimentions 51x86x44cm

**Buy Now!**



**Content for  
Facebook/Instagram**



ACCESSORY  
**STORAGE STAND**

**HOIST**  
FITNESS

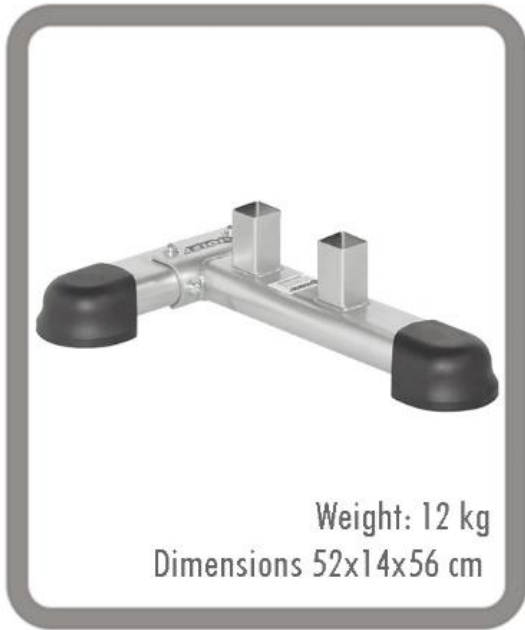

Weight: 12 kg  
Dimensions 52x14x56 cm



**Content for  
Facebook/Instagram**



# MULTI PURPOSE SQUAT RACK



Content for  
Facebook/Instagram





**RACK OUT TIER OPTION**  
FOR  
**HF-5170 & HF-5970 (1 PAIR)**



Weight: 3.4 kg  
Dimensions 11.15X28.1441.52 cm

**Buy Now!**



**Content for  
Facebook/Instagram**



**FITNESS TREE**

**HOIST**  
FITNESS

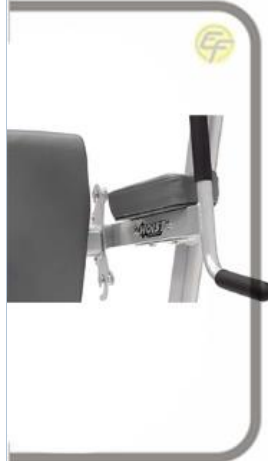

mpare     Add to wishlist

 Add To Compare     Ac

**Buy Now!**

   



**Content for  
Facebook/Instagram**



HF-5165  
7 POSITION F.I.D. BENCH

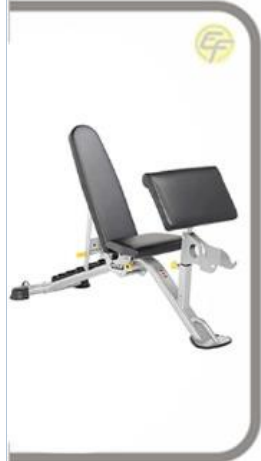

Compare Add to wishlist

Add To Compare Add to wishlist

**Buy Now!**



ECO FITNESS

Content for  
Facebook/Instagram



# HF-4145

## FOLDING MULTI BENCH

### HOIST FITNESS



Compare Add to wishlist

Add To Compare Ac

**Buy Now!**

f p t i

**ECO FITNESS**

Content for  
Facebook/Instagram





# 7 POSITION FOLDING F.I.D. BENCH HF-5167



Compare Add to wishlist

Add To Compare Ac

**Buy Now!**



ECO FITNESS



Content for  
Facebook/Instagram



**Content for  
Facebook/Instagram**

**HOIST**  
FITNESS

**AB/BACK HYPER BENCH**  
**HF-4263**



mpare    Add to wishlist

Add To Compare    Ac

f   p   t   s

**Buy Now!**



**ECO FITNESS**



3PC Filled PUNCH BAG  
BLACK-6Ft



**Buy Now!**



ECO FITNESS

Content for  
Facebook/Instagram



**3PC Filled PUNCH BAG F6  
MATTE BLACK-6FT**



**Buy Now!**



**Content for  
Facebook/Instagram**





**Filled PUNCH BAG LEATHER**  
**PRO BLACK/GOLD-4FT**



**Buy Now!**



**Content for  
Facebook/Instagram**





**Content for  
Facebook/Instagram**

**PUNCH BAG**  
WEIGHT BLACK  
*Kara Design*



**Content for  
Facebook/Instagram**



**FREE STANDING PUNCH BAG  
F6 BLACK-6FT**



**Content for  
Facebook/Instagram**



FREE STANDING PUNCH BAG  
F9 RED/BLACK-6FT



**Buy Now!**

**RDX**  
GIANT INSIDE



**Content for  
Facebook/Instagram**



**FREE STANDING PUNCH BAG AURA**  
**T-17GL-6FT**



**Buy Now!**



**Content for  
Facebook/Instagram**



SPEED DOUBLE END B-BALL YELLOW/BLACK WITH  
**REGULAR ROPE**



Dimension:40.5 cm tall double-end ballLorem Ipsum

**Buy Now!**



**Content for  
Facebook/Instagram**



*IRON QABZA FOLDING WALL BRACKET BLACK HEAVY*



**Buy Now!**



**Content for  
Facebook/Instagram**





*IRON SWIVEL BLACK PRO*



*Buy Now!*



**Content for  
Facebook/Instagram**



**FOCUS PAD T15**  
**MATTE BLACK**



ECO FITNESS

**Content for  
Facebook/Instagram**



# FOCUS PAD **FLORAL BLACK**



**Buy Now!**



**Content for  
Facebook/Instagram**





**Content for  
Facebook/Instagram**



# ARM PAD GEL KICK SHIELD

WHITE/BLACK HEAVY



Dimensions: 60 x 36 x 13 cm  
Strap length: 50 cm

**Buy Now!**



**Content for  
Facebook/Instagram**





Content for  
Facebook/Instagram





Content for  
Facebook/Instagram





**Content for  
Facebook/Instagram**





Content for  
Facebook/Instagram



**PRO Resistance Tube  
with Safety Sleeve**  
*Heavy/Extra Heavy/Light/Medium*



**Content for  
Facebook/Instagram**





**Content for  
Facebook/Instagram**

**ZIVA**

*Performance Balance Ball*



**Buy Now!**

 Add To Compare     Add to wishlist



**Content for  
Facebook/Instagram**



**ZIVA™**

*ZVO Balance Ball*



**Buy Now!**

 Add To Compare

 Add to wishlist



**Content for  
Facebook/Instagram**



**ZIVA**

*Deluxe Foam Yoga Mat (6mm) color Black*



**Buy Now!**

 Add To Compare     Add to wishlist



**Content for  
Facebook/Instagram**



**ZIVA™**

*Performance*  
*Boxing Bandage*  
**Gloves**



**Content for  
Facebook/Instagram**



**ZIVA**

*Performance Boxing Hand Wraps*



**Buy Now!**

 Add To Compare     Add to wishlist



**Content for  
Facebook/Instagram**





**ZIVA**

*ZIVA Performance Boxing Gloves*



**Buy Now!**

Add To Compare Add to wishlist

f p t i

**ECO FITNESS**

**ECO FITNESS**

S

## Content for Facebook/Instagram



Content for  
Facebook/Instagram





Content for  
Facebook/Instagram



*Performance Hex Dumbbell*  
12.5-27.5 kg



Content for  
Facebook/Instagram



**BIOFORM GLOVES**  
L/M/S GRY

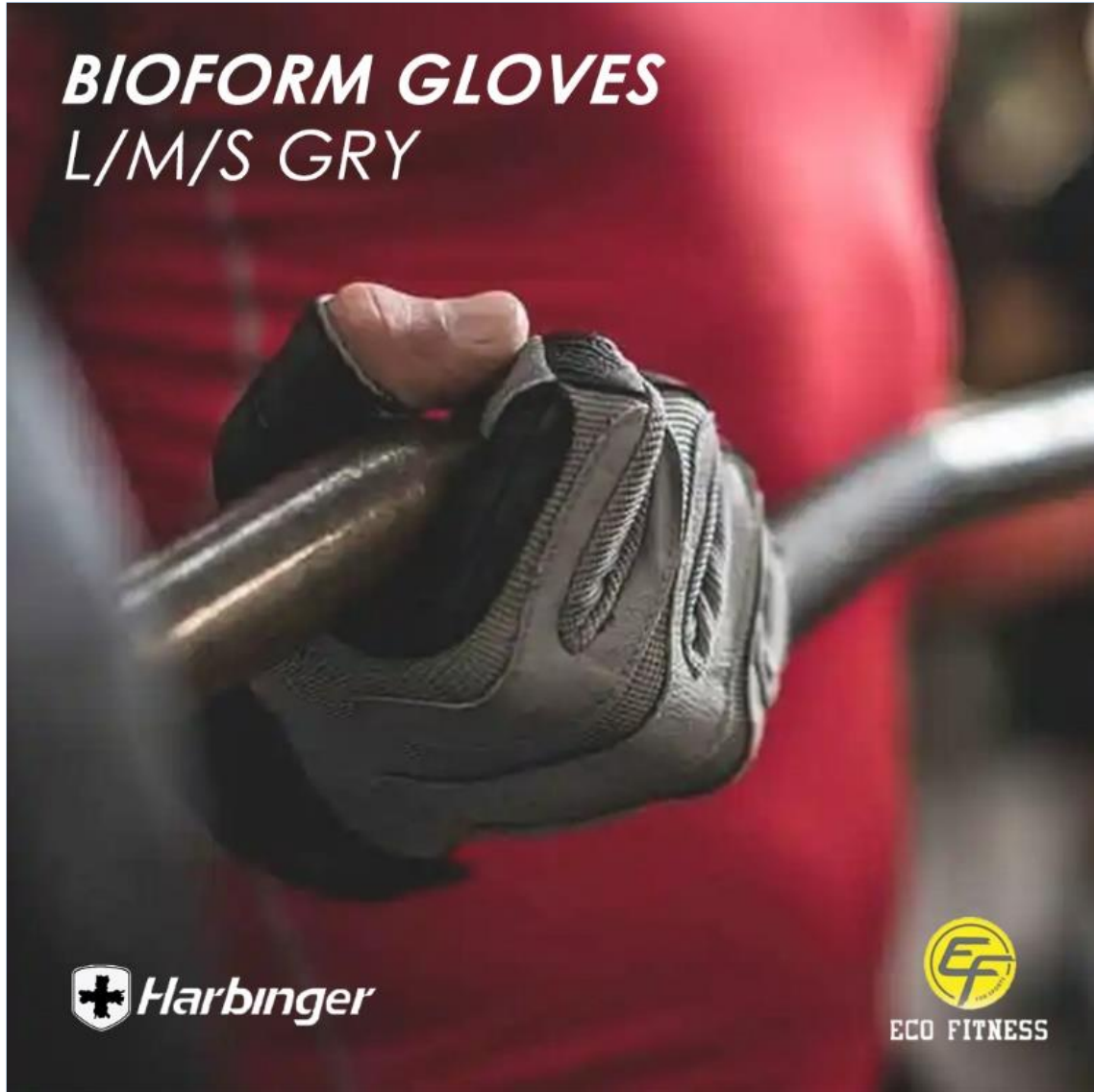

 **Harbinger**

  
ECO FITNESS

**Content for  
Facebook/Instagram**





**Content for  
Facebook/Instagram**



# ***WMNS POWER GLOVES*** *BLK (Medium/Smal/XS Smal)*



 Add To Compare

 Add to wishlist



**Harbinger** 



**Content for  
Facebook/Instagram**





**POWER GLOVES**  
**(L/M/S )BLK**

**Harbinger** 

  
ECO FITNESS

**Content for  
Facebook/Instagram**







Content for  
Facebook/Instagram

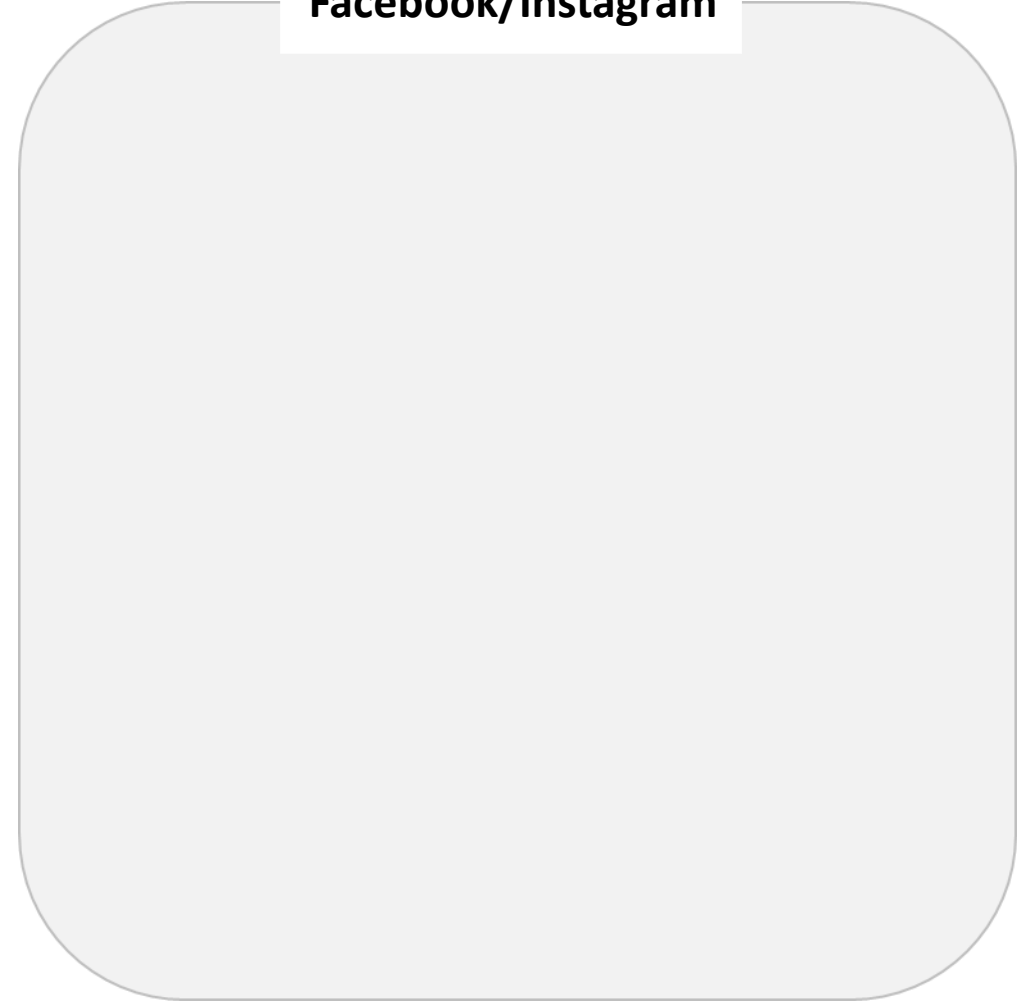

# ***PRO GLOVES*** *(L /M/S )BLK*



**Harbinger** +



**Content for  
Facebook/Instagram**





**Content for  
Facebook/Instagram**



# LIFTING GRIPS

SIM BLACK /M-L BLK



 Add To Compare

 Add to wishlist



**Harbinger** 



Content for  
Facebook/Instagram



Content for  
Facebook/Instagram



**Content for  
Facebook/Instagram**

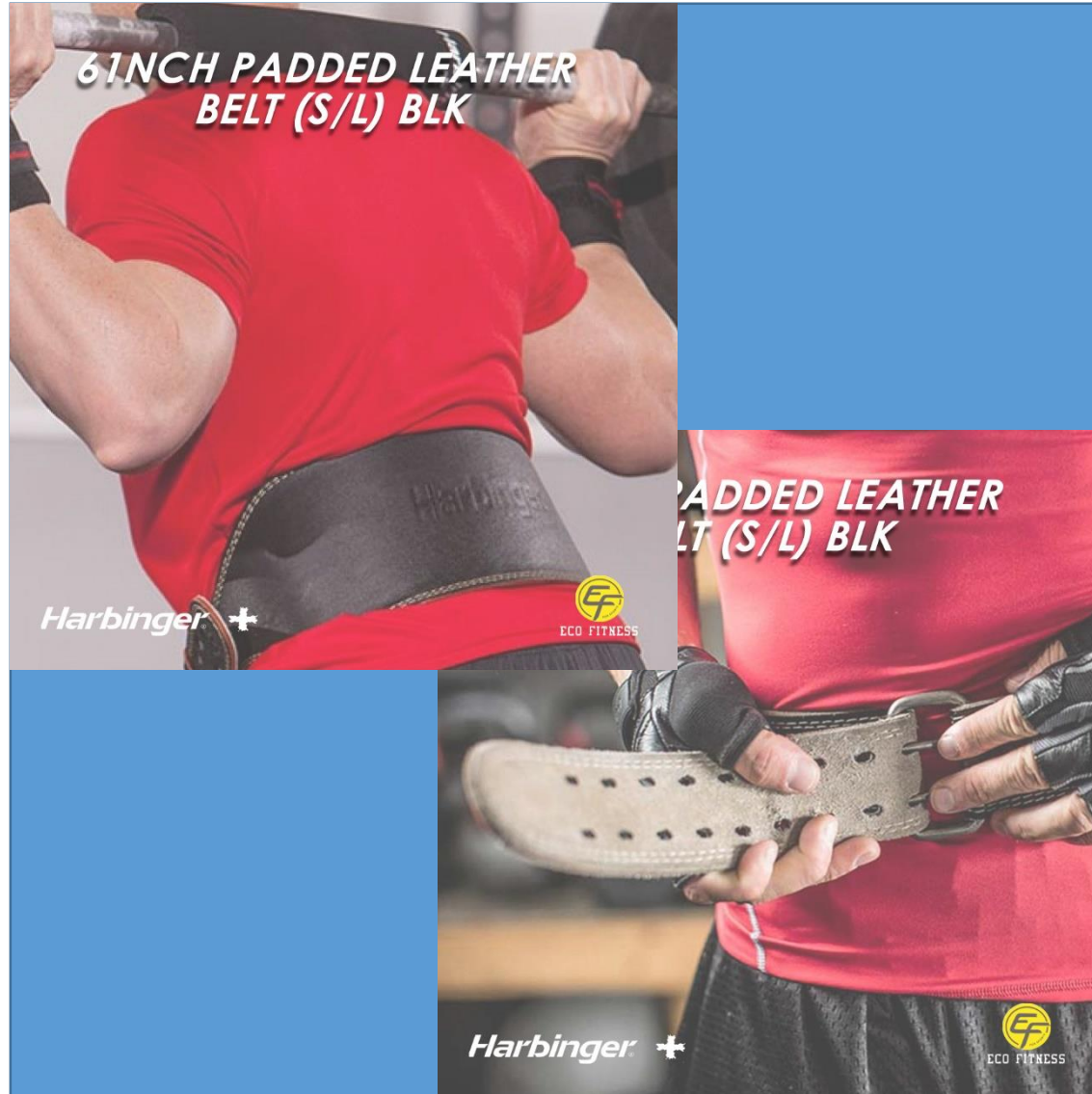



**Content for  
Facebook/Instagram**





Content for  
Facebook/Instagram







Content for  
Facebook/Instagram



# ZIVA

## Weight Vest 5-10 kg



 Add To Compare

 Add to wishlist



ECO FITNESS

### Content for Facebook/Instagram

